

DC motor with optical encoder and gear box

OEM

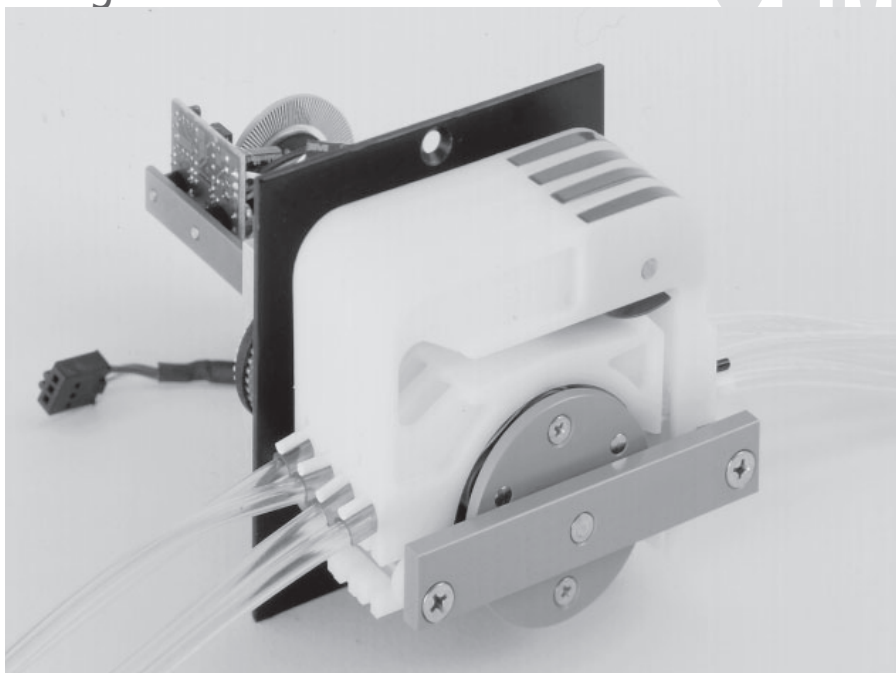

Side view (mm)

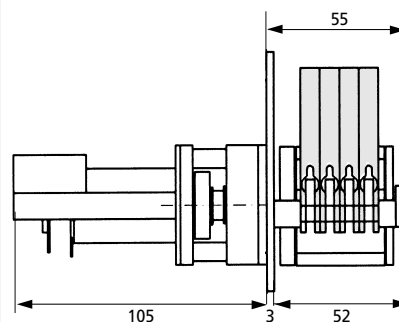

Front view (mm)

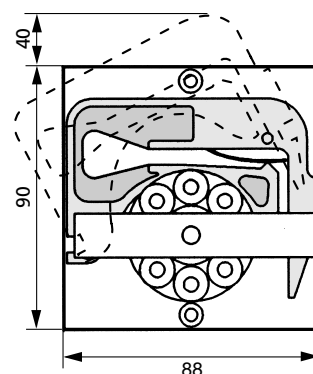

Mounting cut-out (mm)

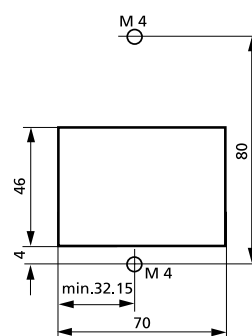
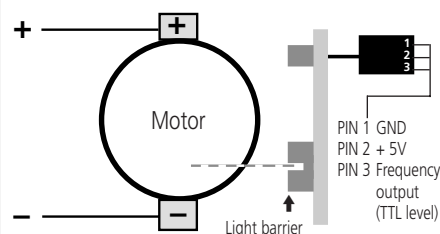

Diagram and electrical connections



*** Please note**

Specifications valid for the following ISMATEC® control units:
 a) REGLO-E Analog - see data sheet 08.1
 b) REGLO-E Digital - see data sheet 08.2

Technical specifications

Pump model	REGLO-E MS/CA4-06
Motor type	DC motor with encoder
Gear ratio	25:1
Rotation speed*	2–100 rpm ^{a)} 1–100 rpm ^{b)}
Flow rates*	0.002–43 ml/min
Motor control*	optional control unit
Power consumption	max. 10 W
Optical encoder	120 impulses/motor rev.
Channels	4
Pump rollers	6
Weight	0.780 kg
Tubing type	3-stop collared tubing
Tubing i.d.	0.13–3.17 mm
Cassettes	MS/CA Click'n'go, POM

Cassettes (Spare part / Option)
 IS 3510 MS/CA Click'n'go, POM-C ²⁾
 IS 0649 MS/CA Pressure lever, POM-C
 IS 3629 MS/CA Pressure lever, PVDF

²⁾ Standard equipment
 ➔ Please see data sheet 09.1

Flow rates¹⁾

Tubing i.d. mm	ml per revolution	Tubing i.d. mm	ml per revolution
0.13	0.0014	1.14	0.09
0.19	0.0028	1.22	0.10
0.25	0.0048	1.30	0.11
0.38	0.011	1.42	0.13
0.44	0.014	1.52	0.15
0.51	0.019	1.65	0.17
0.57	0.024	1.75	0.19
0.64	0.030	1.85	0.21
0.76	0.042	2.06	0.25
0.89	0.057	2.29	0.29
0.95	0.064	2.54	0.33
1.02	0.073	2.79	0.37
1.09	0.083	3.17	0.43

¹⁾ Water, Tygon® tubing, without differential pressure

➔ Calculation example for flow rate
 rpm x ml per revolution = ml/min
 100 x 0.43 = 43

Ask for the ISMATEC® Pump Tubing Selection Guide.

Ordering information

Nominal voltage	Type REGLO-E MS/CA4-06	Order No.
12 V _{DC}		IS 3182

Data sheet
 02.3.13
 30.09.05